



ALSANIT®

# TAURUS

## TAURUS



# TAURUS HPL lockers

## Body:

**HPL** - High pressure laminate

## Doors:

**HPL** - High pressure laminate

 Prepared for  
**Smart Locker**

page 15 →



Protected design  
WP.30407 (hinge)

## Description:







HPL panels are a modern material of the 21st century, characterized by exceptional durability, waterproof properties, and antibacterial features. When investing in clothing lockers, customers expect years of durability, and no other material provides such excellent longevity and functionality.

HPL lockers perform exceptionally well in extreme conditions, for example, in food processing plants or swimming pools, where aggressive environments and con-

tinuous user rotation cause high impact on the lockers.

HPL panels are offered in natural decors and textures such as stone, concrete, or wood, allowing for the creation of unique compositions.

TAURUS lockers, extremely durable and easy to maintain, are custom-made at no extra charge. To learn more, please contact us. Choosing HPL lockers from ALSANIT guarantees satisfaction.

-  only Torx screws are used
-  fully assembled product
-  the possibility of custom built
-  smooth inner walls
-  custom sizing available
-  easy to clean



**Quality confirmed by certificates**



**100% waterproof**



**Even gaps between the doors**



**Frontlaying doors**



**The most durable on the market**



**Antibacterial and antifungal properties**

### Standard dimensions

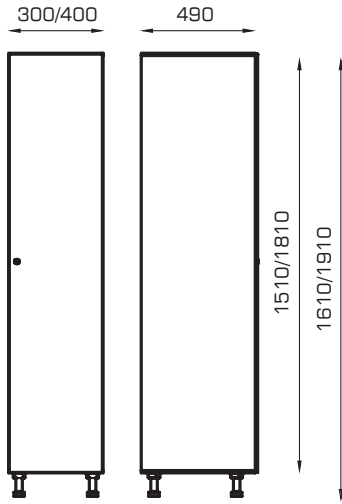

### Base options

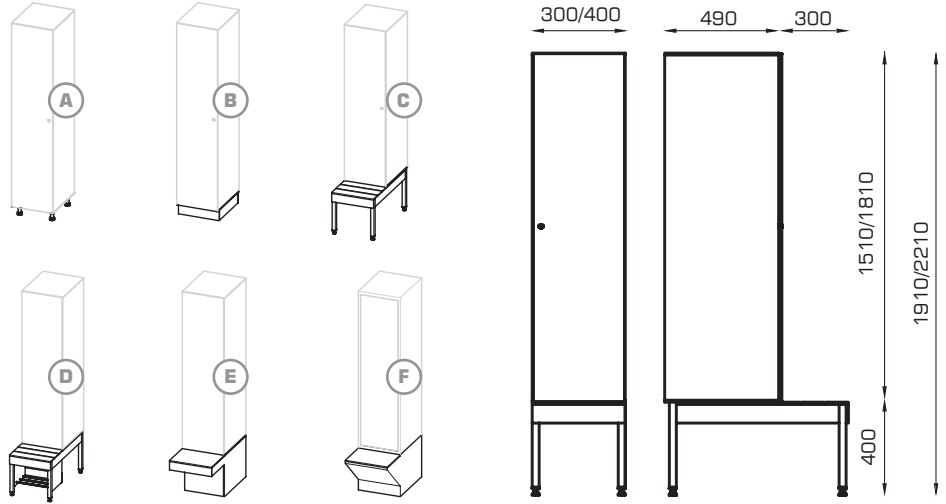

### Standard equipment

patented hinge  
manufactured by ALSANIT



stable, aluminum rod  
and durable hooks  
manufactured by ALSANIT



as a standard - key lock  
or a padlock



**doors: HPL 10/12 mm**

**body: HPL 10 mm**  
**back: HPL 4 mm**

polyamide leg



available additional  
options

page 8 →

available lock  
options

page 14 →

available  
colors

page 18 →



# TAURUS HPL lockers

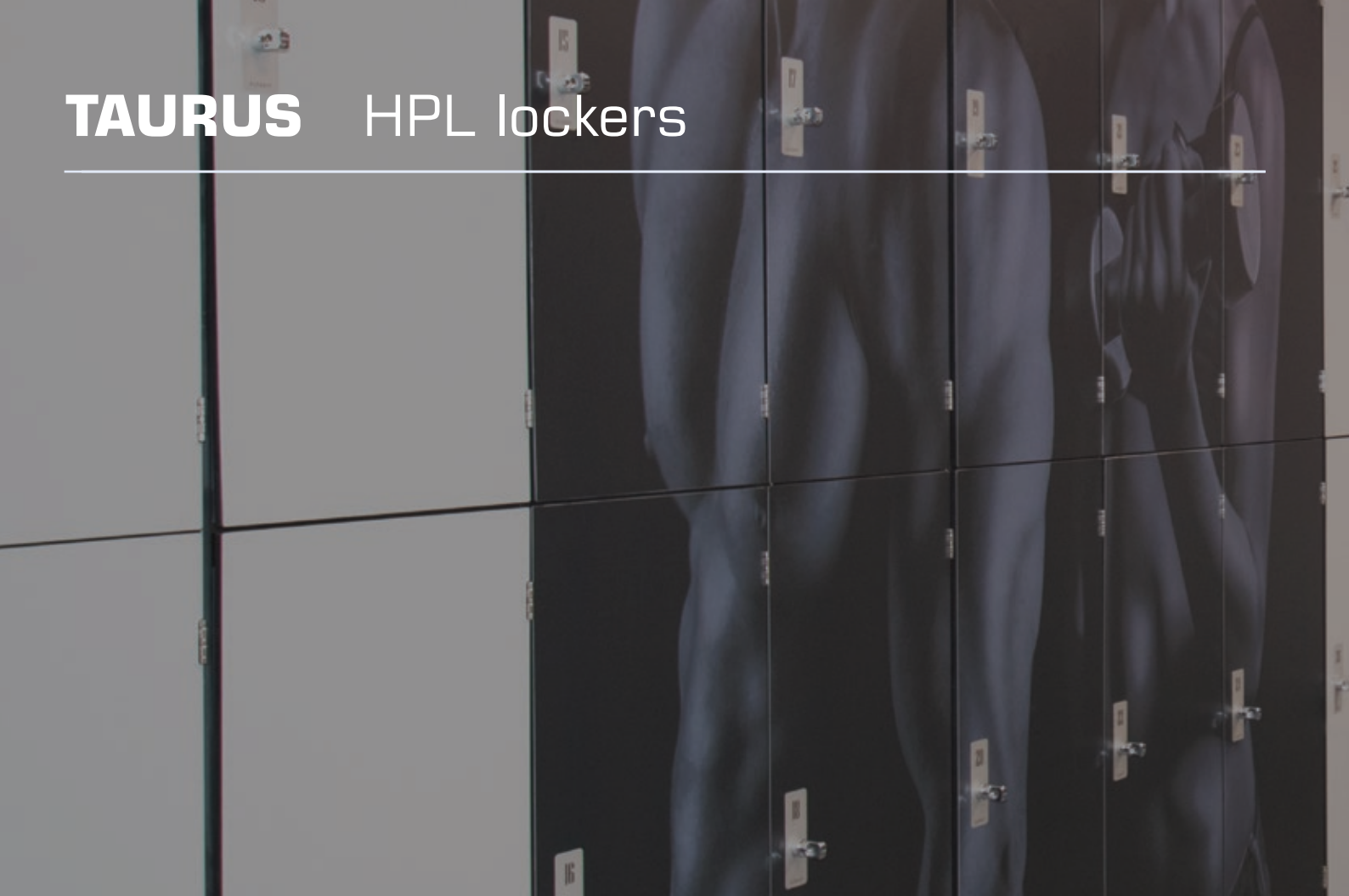

## Single-level lockers

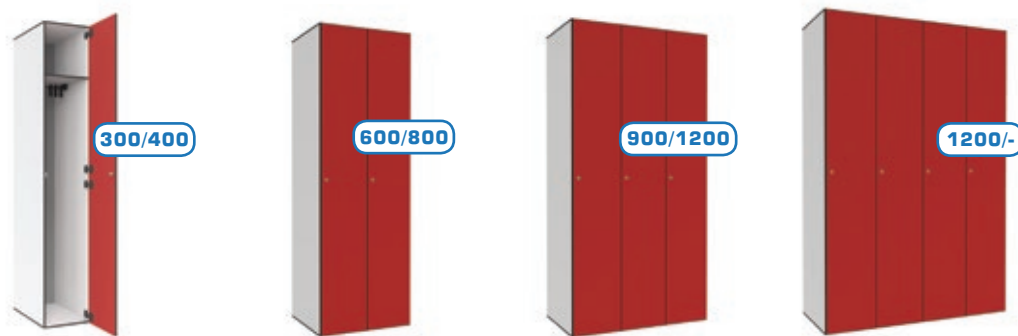

### STANDARD VERSION

DIMENSIONS	<b>PRODUCT CODE</b>	TD-15311-01	TD-15411-01	TD-15321-01	TD-15421-01	TD-15331-01	TD-15431-01	TD-15341-01	-
	<b>HEIGHT</b>	1510	1510	1510	1510	1510	1510	1510	-
	<b>PRODUCT CODE</b>	TD-18311-01	TD-18411-01	TD-18321-01	TD-18421-01	TD-18331	TD-18431-01	TD-18341-01	-
	<b>HEIGHT</b>	1810	1810	1810	1810	1810	1810	1810	-
	<b>OVERALL WIDTH</b>	300	400	600	800	900	1200	1200	-
	<b>COLUMN WIDTH</b>	1X300	1X400	2X300	2X400	3X300	3X400	4X300	-
	<b>DEPTH</b>	490	490	490	490	490	490	490	-
EQUIPMENT	<b>LEGS HEIGHT 100</b>	✓	✓	✓	✓	✓	✓	✓	-
	<b>SHELF</b>	✓	✓	✓	✓	✓	✓	✓	-
	<b>BAR WITH HOOKS</b>	✓	✓	✓	✓	✓	✓	✓	-
	<b>CLOTHING HOOK</b>	✓	✓	✓	✓	✓	✓	✓	-
	<b>KEY LOCK</b>	✓	✓	✓	✓	✓	✓	✓	-
	<b>PADLOCK LOCK</b>	✓	✓	✓	✓	✓	✓	✓	-

+	<b>TYPES OF LOCKS</b>	AVAILABLE TYPES OF LOCKS: PAGE 14
	<b>ADDITIONAL OPTIONS</b>	AVAILABLE ADDITIONAL OPTIONS: PAGE 8
	<b>COLOR OPTIONS</b>	AVAILABLE COLOR OPTIONS: PAGE 18

# TAURUS

## Two-level lockers



### STANDARD VERSION

DIMENSIONS	PRODUCT CODE	TD-15312-01	TD-15412-01	TD-15322-01	TD-15422-01	TD-15332-01	TD-15432-01	TD-15342-01	-
	HEIGHT	1510	1510	1510	1510	1510	1510	1510	-
	PRODUCT CODE	TD-18312-01	TD-18412-01	TD-18322-01	TD-18422-01	TD-18332-01	TD-18432-01	TD-18342-01	-
	HEIGHT	1810	1810	1810	1810	1810	1810	1810	-
	OVERALL WIDTH	300	400	600	800	900	1200	1200	-
	COLUMN WIDTH	1X300	1X400	2X300	2X400	3X300	3X400	4X300	-
	DEPTH	490	490	490	490	490	490	490	-
EQUIPMENT	LEGS HEIGHT 100	✓	✓	✓	✓	✓	✓	✓	-
	SHELF	✓	✓	✓	✓	✓	✓	✓	-
	BAR WITH HOOKS	✓	✓	✓	✓	✓	✓	✓	-
	CLOTHING HOOK	✓	✓	✓	✓	✓	✓	✓	-
	KEY LOCK	✓	✓	✓	✓	✓	✓	✓	-
	PADLOCK LOCK	✓	✓	✓	✓	✓	✓	✓	-

+	TYPES OF LOCKS	AVAILABLE TYPES OF LOCKS: PAGE 14
	ADDITIONAL OPTIONS	AVAILABLE ADDITIONAL OPTIONS: PAGE 8
	COLOR OPTIONS	AVAILABLE COLOR OPTIONS: PAGE 18

# TAURUS HPL lockers

## Three-level lockers



STANDARD VERSION

DIMENSIONS	PRODUCT CODE	TD-15313-00	TD-15413-00	TD-15323-00	TD-15423-00	TD-15333-00	TD-15433-00	TD-15343-00	-
	HEIGHT	1510	1510	1510	1510	1510	1510	1510	-
	PRODUCT CODE	TD-18313-00	TD-18413-00	TD-18323-00	TD-18423-00	TD-18333-00	TD-18433-00	TD-18343-00	-
	HEIGHT	1810	1810	1810	1810	1810	1810	1810	-
	OVERALL WIDTH	300	400	600	800	900	1200	1200	-
	COLUMN WIDTH	1X300	1X400	2X300	2X400	3X300	3X400	4X300	-
DEPTH	490	490	490	490	490	490	490	-	
EQUIPMENT	LEGS HEIGHT 100	✓	✓	✓	✓	✓	✓	✓	-
	SHELF	-	-	-	-	-	-	-	-
	BAR WITH HOOKS	-	-	-	-	-	-	-	-
	CLOTHING HOOK	✓	✓	✓	✓	✓	✓	✓	-
	KEY LOCK	✓	✓	✓	✓	✓	✓	✓	-
PADLOCK LOCK	✓	✓	✓	✓	✓	✓	✓	-	
+	TYPES OF LOCKS	AVAILABLE TYPES OF LOCKS: PAGE 14							
	ADDITIONAL OPTIONS	AVAILABLE ADDITIONAL OPTIONS: PAGE 8							
	COLOR OPTIONS	AVAILABLE COLOR OPTIONS: PAGE 18							

## Five-level lockers



STANDARD VERSION

DIMENSIONS	PRODUCT CODE	TD-15315-00	TD-15415-00	TD-15325-00	TD-15425-00	TD-15335-00	TD-15435-00	TD-15345-00	-
	HEIGHT	1510	1510	1510	1510	1510	1510	1510	-
	PRODUCT CODE	TD-18315-00	TD-18415-00	TD-18325-00	TD-18425-00	TD-18335-00	TD-18435-00	TD-18345-00	-
	HEIGHT	1810	1810	1810	1810	1810	1810	1810	-
	OVERALL WIDTH	300	400	600	800	900	1200	1200	-
	COLUMN WIDTH	1X300	1X400	2X300	2X400	3X300	3X400	4X300	-
DEPTH	490	490	490	490	490	490	490	-	
EQUIPMENT	LEGS HEIGHT 100	✓	✓	✓	✓	✓	✓	✓	-
	SHELF	-	-	-	-	-	-	-	-
	BAR WITH HOOKS	-	-	-	-	-	-	-	-
	CLOTHING HOOK	-	-	-	-	-	-	-	-
	KEY LOCK	✓	✓	✓	✓	✓	✓	✓	-
PADLOCK LOCK	✓	✓	✓	✓	✓	✓	✓	-	
+	TYPES OF LOCKS	AVAILABLE TYPES OF LOCKS: PAGE 14							
	ADDITIONAL OPTIONS	AVAILABLE ADDITIONAL OPTIONS: PAGE 8							
	COLOR OPTIONS	AVAILABLE COLOR OPTIONS: PAGE 18							

## Four-level lockers



### STANDARD VERSION

DIMENSIONS	PRODUCT CODE	TD-15314-00	TD-15414-00	TD-15324-00	TD-15424-00	TD-15334-00	TD-15434-00	TD-15344-00	-
	HEIGHT	1510	1510	1510	1510	1510	1510	1510	-
	PRODUCT CODE	TD-18314-00	TD-18414-00	TD-18324-00	TD-18424-00	TD-18334-00	TD-18434-00	TD-18344-00	-
	HEIGHT	1810	1810	1810	1810	1810	1810	1810	-
	OVERALL WIDTH	300	400	600	800	900	1200	1200	-
	COLUMN WIDTH	1X300	1X400	2X300	2X400	3X300	3X400	4X300	-
DEPTH	490	490	490	490	490	490	490	-	
EQUIPMENT	LEGS HEIGHT 100	✓	✓	✓	✓	✓	✓	✓	-
	SHELF	-	-	-	-	-	-	-	-
	BAR WITH HOOKS	-	-	-	-	-	-	-	-
	CLOTHING HOOK	-	-	-	-	-	-	-	-
	KEY LOCK	✓	✓	✓	✓	✓	✓	✓	-
PADLOCK LOCK	✓	✓	✓	✓	✓	✓	✓	-	
+	TYPES OF LOCKS	AVAILABLE TYPES OF LOCKS: PAGE 14							
	ADDITIONAL OPTIONS	AVAILABLE ADDITIONAL OPTIONS: PAGE 8							
	COLOR OPTIONS	AVAILABLE COLOR OPTIONS: PAGE 18							

## Clothing lockers L



### STANDARD VERSION

DIMENSIONS	PRODUCT CODE	TZ-15312-00	TZ-15412-00	TZ-15322-00	TZ-15422-00	TZ-15332-00	TZ-15432-00	TZ-15342-00	-
	HEIGHT	1510	1510	1510	1510	1510	1510	1510	-
	PRODUCT CODE	TZ-18312-00	TZ-18412-00	TZ-18322-00	TZ-18422-00	TZ-18332-00	TZ-18432-00	TZ-18342-00	-
	HEIGHT	1810	1810	1810	1810	1810	1810	1810	-
	OVERALL WIDTH	300	400	600	800	900	1200	1200	-
	COLUMN WIDTH	1X300	1X400	2X300	2X400	3X300	3X400	4X300	-
DEPTH	490	490	490	490	490	490	490	-	
EQUIPMENT	LEGS HEIGHT 100	✓	✓	✓	✓	✓	✓	✓	-
	SHELF	-	-	-	-	-	-	-	-
	BAR WITH HOOKS	✓	✓	✓	✓	✓	✓	✓	-
	CLOTHING HOOK	✓	✓	✓	✓	✓	✓	✓	-
	KEY LOCK	✓	✓	✓	✓	✓	✓	✓	-
PADLOCK LOCK	✓	✓	✓	✓	✓	✓	✓	-	
+	TYPES OF LOCKS	AVAILABLE TYPES OF LOCKS: PAGE 14							
	ADDITIONAL OPTIONS	AVAILABLE ADDITIONAL OPTIONS: PAGE 8							
	COLOR OPTIONS	AVAILABLE COLOR OPTIONS: PAGE 18							

# Additional options



## AVAILABLE FOR LOCKERS MADE OF:

	HPL	METAL	MFC
<b>PLATE 30X30</b>	✓	✓	✓
<b>PLATE 35X60</b>	✓	✓	✓
<b>PLATE 45X120</b>	✓	✓	✓
<b>ENGRAVING</b>	✓	-	-
<b>BAR WITH HOOKS</b>	✓	✓	✓
<b>ANTI-BURGLARY SYSTEM</b>	✓	-	✓

## POSSIBILITY OF MAKING FROM:

	HPL	METAL	MFC
<b>CUSTOM DIVISION</b>	✓	✓	✓
<b>SLANTED ROOF</b>	✓	✓	-
<b>PLINTH</b>	✓	✓	✓
<b>LEG COVERS</b>	✓	-	✓





**Connecting lockers into wardrobes**

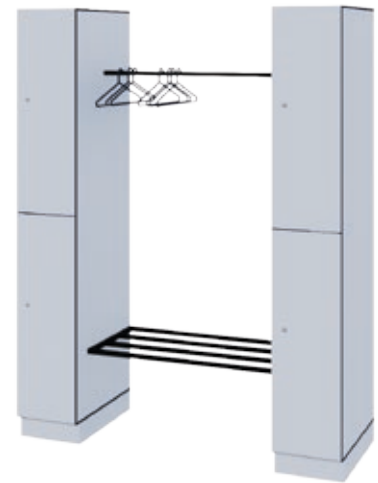
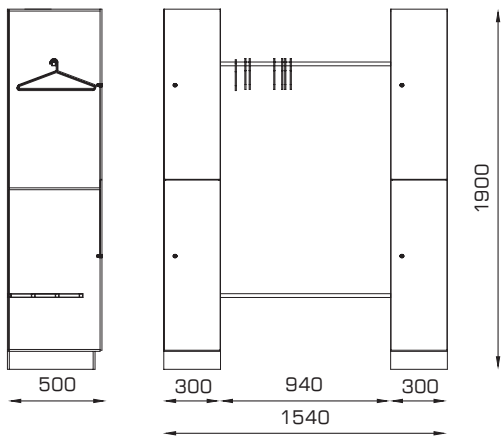

**Side and corner covers**

**HPL / MFC / METAL**



**MIRROR**

**HPL / MFC / METAL**

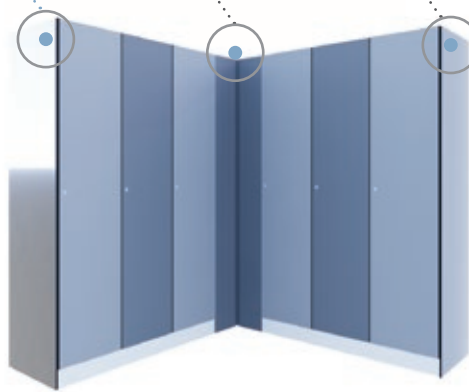

**VANITY - functional and compact**





# BENCHES

**Benches are the perfect add on to any locker room.**

Properly chosen, they can add character to the interior - make it more friendly and inviting.

available  
colors



page 18 →

## Benches PRO-FI

HPL

[← back](#)

10 mm

12 mm

### Classic approach

Aluminum construction with seats made of HPL.  
Standard ALSANIT benches.

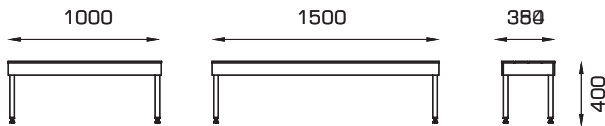
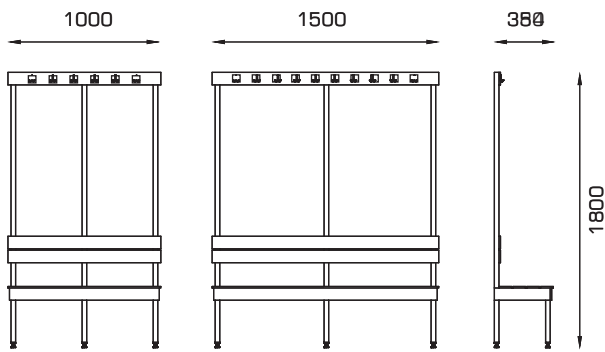

## Benches LO-FI

HPL

10 mm

12 mm

### Metal bench with an eye-catching seat

An elegant combination of steel and wood-like HPL panels.  
Optionally include hooks.

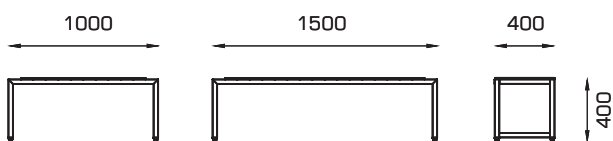
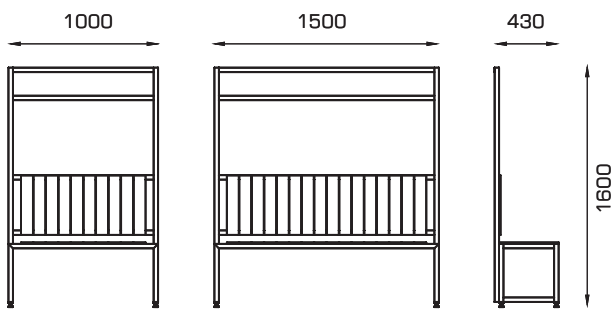

## Benches HI-FI

HPL

10 mm

12 mm

### Openwork backs

Steel frames with HPL seats.

Optionally include hooks.

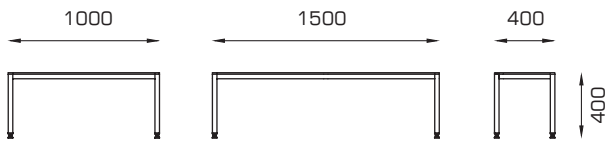
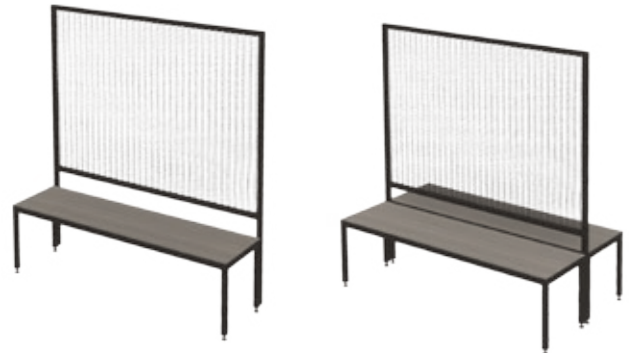
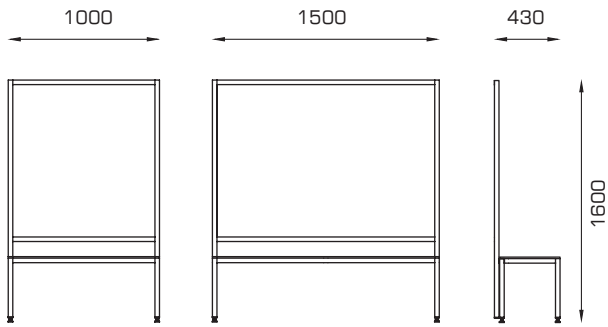

### Options - available for any model

### Option with low backrest

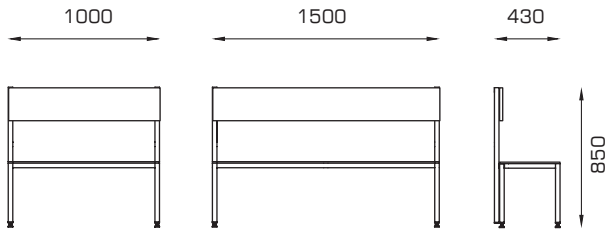

### Optional slat direction for seats

### Optional shoe shelf



## Upholstered benches

← back

### Elegance and comfort

The combination of a classic bench with elegant upholstery  
- beauty and elegance encapsulated in a simple minimalist  
form. Perfect for both modern and classical interiors.

### IRIS

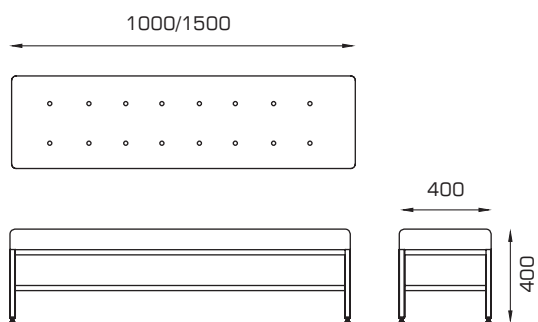

### LANDO

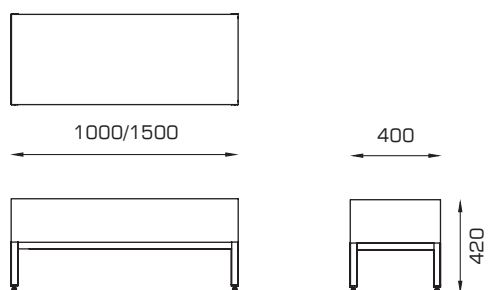

# Locks for lockers

**Security** - a common value of the locks we offer, that is why we only provide those from reputable manufacturers. Below, we describe three additional features that guided us in selecting the locks for our products.

**Waterproofnes** - prepared to work in any conditions.

Prioritizing quality above all, we have decided that all locks offered by us are suitable for use in moist areas.

**Interchangeability** - lock models can be exchanged at any time, changing from a lower model to a higher one. This way, the locker room can be modernized without the need for costly door replacement. When changing locks to deposit or electronic locks, additional holes will have to be made in doors.

**Availability** - don't waste time waiting.

A strong aspect of our offer is the availability of locks on stock, significantly reducing the time needed to complete the order. For projects with slot or digital locks above 200 compartments, please contact us to confirm availability.

**Cam locks**, the locks we offer have a 1/1000 combination, meaning the chance of opening with your key any another locker is 0.1%.



**Padlock locks**, an alternative to key locks is padlocks. The recommended shackle diameter for padlocks is 5-7 mm.



## The option to use any lock.

We are not limited to our own selection; we can integrate the locker with any lock specified by the client.

**Code locks** are maintenance-free solutions. All code locks offered by us have a master key opening option in case the code is forgotten.



**Deposit locks**, Coin-operated or token-operated locks are capable of accepting coins or tokens into a special container. Locks can operate on coins of 1/2 EUR. In case of key loss, locks can be opened using a master key.



**Electronic lock** that support the standard RFID are modern programmable locks operated by CARDS, WRISTBANDS, or other RFID TOKENS. Available in both OFFLINE versions powered by batteries and ONLINE versions powered externally.





### SMART LOCKER transforms lockers into solutions

ALSANIT introduces innovative solutions in the field of lockers with smart locks, enabling electronic control over them.

Thanks to cooperation with the renowned brand SMART LOCKER, representing the most advanced intelligent locking system available on the market, we can confidently offer this solution to our customers.

SMART LOCKER stands out not only for its ease of use but also for its rich configuration options, ensuring easy management and convenient use.



**The possibility of integration for any ALSANIT locker system**



**Full service including installation and training**



**The ability to integrate with the client's database**



**The ability to customize the software to individual needs**

**SMART LOCKER is an intelligent locker system that introduces a new era of facility management.**

### Examples of applications by industry

#### INDUSTRIES

	OFFICES	SCHOOLS	STORES	PHARMACY	FACTORIES	SPORTS FACILITIES	LOGISTICS SHIPMENTS	HEALTHCARE	PUBLIC AREAS	GASTRONOMY
<b>FUNCTIONS</b>										
<b>STORAGE</b>	✓	✓				✓		✓	✓	✓
<b>DISPENSE</b>	✓	✓	✓	✓	✓	✓	✓	✓		
<b>DROP OFF / PICK UP</b>	✓	✓	✓		✓		✓		✓	
<b>CLOAKROOM</b>	✓	✓	✓		✓	✓	✓	✓	✓	✓

- Receive all your parcels from any carrier in one place.
- Effortlessly dispense workwear or distribute mail.
- Exchange documents or keys using easily managed lockers.
- Reduce costs by flexibly assigning users to lockers in the changing room.
- Control the circulation of tools or electronic equipment.
- Earn money by selling oversized items in hospitals, sports facilities, etc.

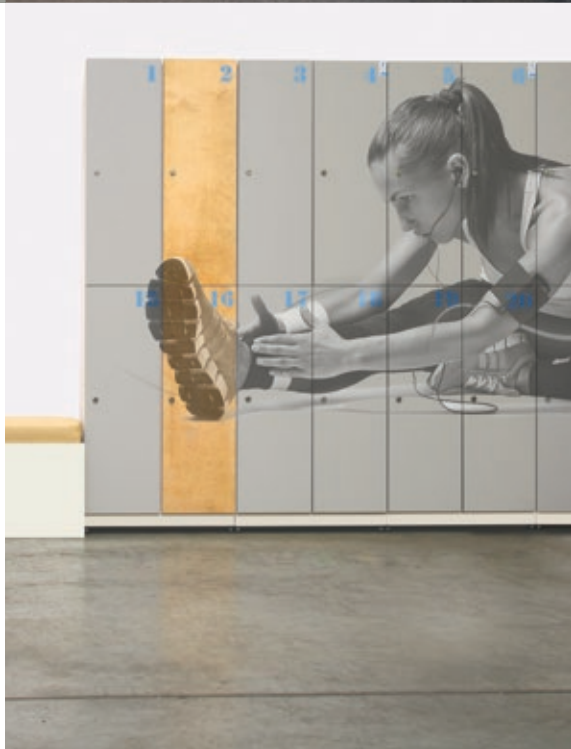



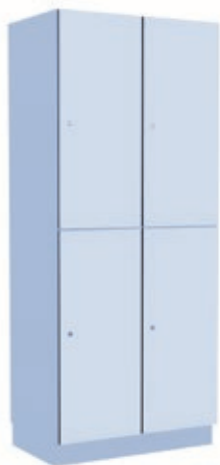

## The **STOCK** version - at no extra cost

Take advantage of our extensive stock collection of available HPL, MFC, and GLASS, as well as metal paint, and configure furniture at no extra cost. There are countless configuration possibilities.

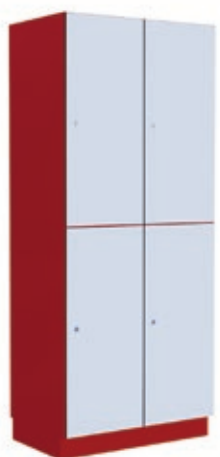

## The **EXTENDED** Version - extra charge

If you would like to have the furniture bodies made in colors other than those originally designated for bodies, there is an additional surcharge of +15%.



## **BESPOKE** Version - custom color scheme upon individual request

In addition to non-standard board colors, we can also enrich the project with graphics or decals. If you wish for colors not available in our warehouse collection, you can choose any board color, paint, or decor from the available palette, and we will order it for you.

HPL + MFC - available from the ALSANIT board suppliers' collections  
PAINT FOR METAL + GLASS - available from the RAL color collection

# COLORS stock collection

## HPL

LOCKERS

HPL BUILT-INS

CUBICLES

CONTRACT FURNITURE

standard colors of locker bodies  
standard colors of Sandwich Panels



colors available only for lockers and furniture

## METAL

LOCKERS

standard colors of locker bodies

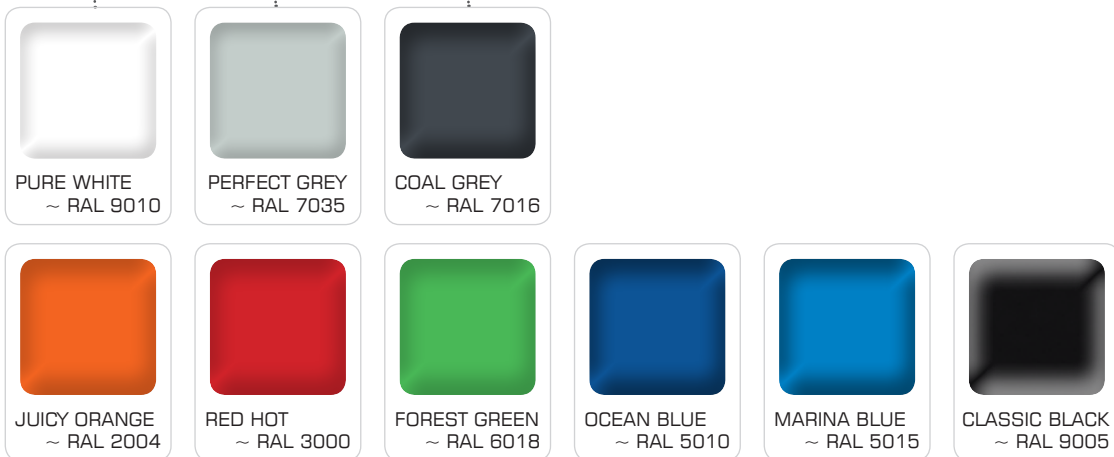

\* sample colors

## MFC

LOCKERS

CUBICLES

CONTRACT FURNITURE

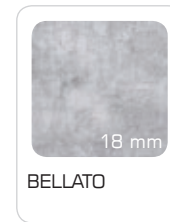
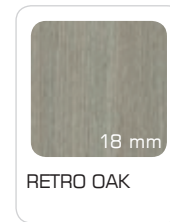
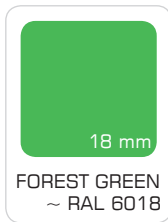
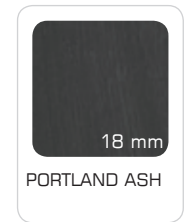
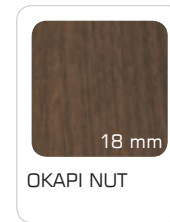
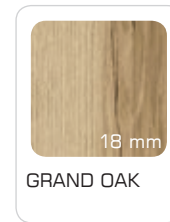
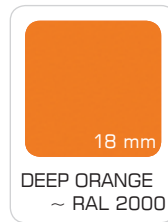
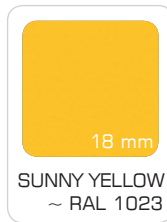
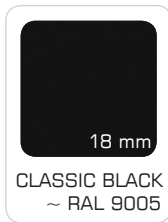
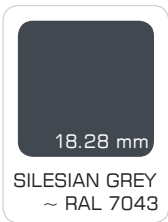
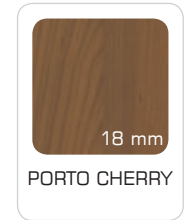
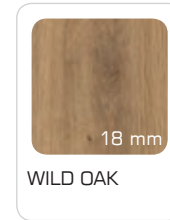
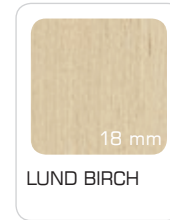
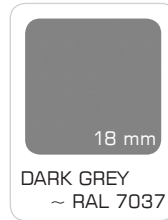
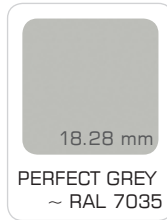
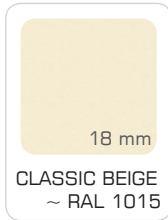
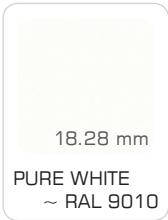

the color range is also available in the HIGH GLOSS version

## GLASS

LOCKERS

CUBICLES

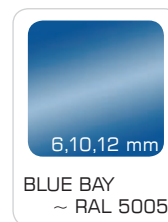
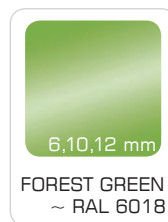
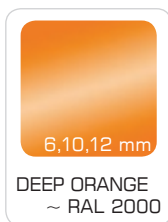
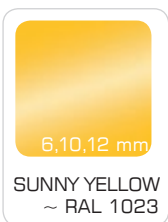
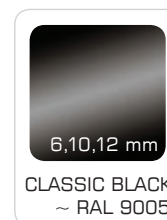
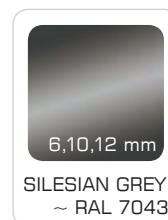
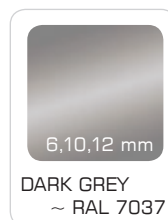
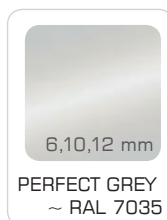
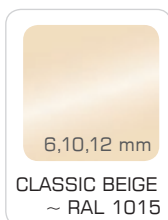
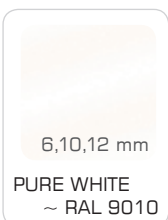

\* sample colors

**20+**

20 years of experience

**25+**

sales to over 25 countries

**2600+**

2600 projects annually

**8000+**

sqm of ALSANIT's hall space

**40000+**

doors produced annually

## HPL series TAURUS lockers are a revolution in the world of clothing lockers.

Extremely durable, easy to maintain. Available in natural decors and textures such as stone, concrete or wood.



ALSANIT®

Alsanit Sp. z o.o.  
ul. Wieleńska 2, 64-980 Trzcianka, POLSKA

+48 67 253 23 60  
export@alsanit.eu  
www.alsanit.eu