



ALSANIT®

ARTUS

ARTUS



ARTUS HPL lockers on profiles

Body:

HPL - High pressure laminate
ALUMINUM - Anodized aluminum profiles

Doors:

HPL - High pressure laminate

 Prepared for
Smart Locker

[page 17](#) →



Patents:
P.220888 (profile system)
P.425699 (hidden hinge)
Protected design:
WR.30407 (hinge)

Description:

ARTUS series lockers are distinguished by specially designed structural profiles. They allow for the installation of additional options:

- AQUARI hinges that open at 180 degrees and allow for the construction of PIANO doors,
- LED lighting, which gives the lockers a modern and eye-catching character. The mounting socket for these elements if not used is discreetly hidden behind an elegant aluminum cover.

Thanks to innovative solutions, these

lockers offer the possibility of configuration to any dimension, maximally meeting individual needs.

Although initially HPL lockers were intended for use in swimming pools, their excellent properties have led to their application in many other facilities.

Investing in ARTUS lockers is a choice of uncompromising quality. Designed for durability, functionality and elegant appearance, they prove that excellence is within reach of each of our customers.

 only Torx screws are used

 fully assembled product

 custom sizing available

 the possibility of custom built

 easy to clean



Patented profile system



**Piano door option
„Finger-safe”**

[page 8](#) →



**Option to use LED
lighting**



Frontlaying doors



100% waterproof



**Antibacterial and
antifungal properties**

Standard dimensions

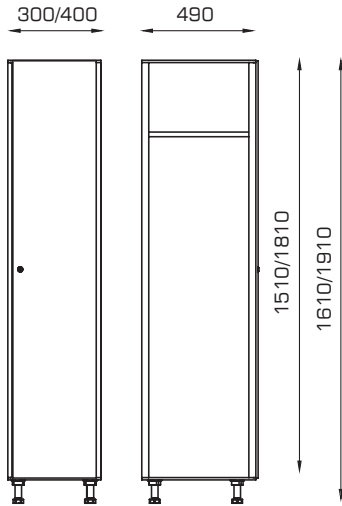

Base options

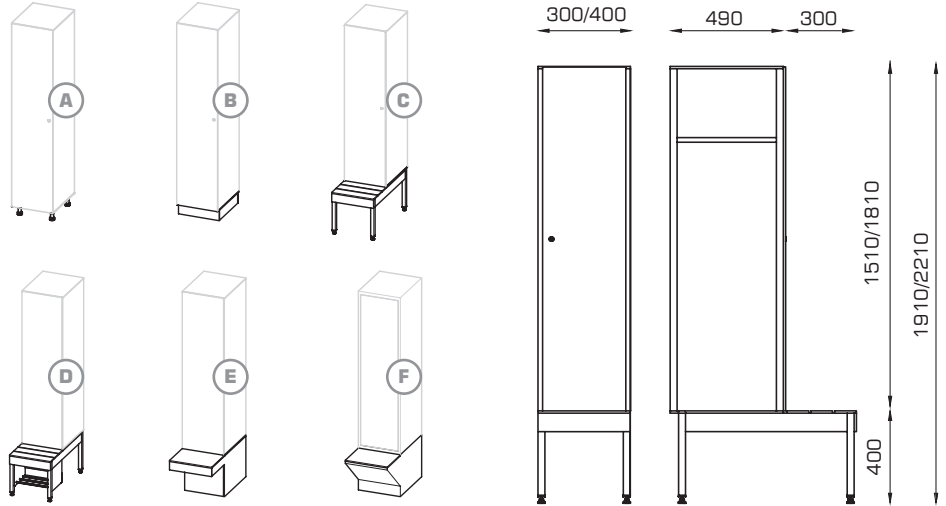

Standard equipment

patented hinge
manufactured by ALSANIT



stable, aluminum rod
and durable hooks
manufactured by ALSANIT



as a standard - key lock
or a padlock



doors: HPL 10/12 mm

body and back: HPL 4 mm

polyamide leg



available additional
options

page 10 →

available lock
options

page 16 →

available
colors

page 20 →



ARTUS HPL lockers on profiles



Single-level lockers

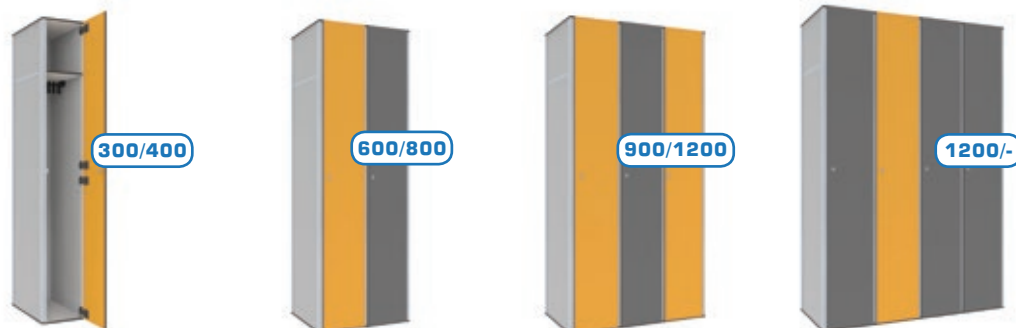

STANDARD VERSION

DIMENSIONS	PRODUCT CODE	AD-15311-01	AD-15411-01	AD-15321-01	AD-15421-01	AD-15331-01	AD-15431-01	AD-15341-01	-
	HEIGHT	1510	1510	1510	1510	1510	1510	1510	-
	PRODUCT CODE	AD-18311-01	AD-18411-01	AD-18321-01	AD-18421-01	AD-18331-01	AD-18431-01	AD-18341-01	-
	HEIGHT	1810	1810	1810	1810	1810	1810	1810	-
	OVERALL WIDTH	300	400	600	800	900	1200	1200	-
	COLUMN WIDTH	1X300	1X400	2X300	2X400	3X300	3X400	4X300	-
	DEPTH	490	490	490	490	490	490	490	-
EQUIPMENT	LEGS HEIGHT 100	✓	✓	✓	✓	✓	✓	✓	-
	SHELF	✓	✓	✓	✓	✓	✓	✓	-
	BAR WITH HOOKS	✓	✓	✓	✓	✓	✓	✓	-
	CLOTHING HOOK	✓	✓	✓	✓	✓	✓	✓	-
	KEY LOCK	✓	✓	✓	✓	✓	✓	✓	-
	PADLOCK LOCK	✓	✓	✓	✓	✓	✓	✓	-
+	TYPES OF LOCKS	AVAILABLE TYPES OF LOCKS: PAGE 16							
	ADDITIONAL OPTIONS	AVAILABLE ADDITIONAL OPTIONS: PAGE 10							
	COLOR OPTIONS	AVAILABLE COLOR OPTIONS: PAGE 20							



Two-level lockers



STANDARD VERSION

DIMENSIONS	PRODUCT CODE	AD-15312-01	AD-15412-01	AD-15322-01	AD-15422-01	AD-15332-01	AD-15432-01	AD-15342-01	-
	HEIGHT	1510	1510	1510	1510	1510	1510	1510	-
	PRODUCT CODE	AD-18312-01	AD-18412-01	AD-18322-01	AD-18422-01	AD-18332-01	AD-18432-01	AD-18342-01	-
	HEIGHT	1810	1810	1810	1810	1810	1810	1810	-
	OVERALL WIDTH	300	400	600	800	900	1200	1200	-
	COLUMN WIDTH	1X300	1X400	2X300	2X400	3X300	3X400	4X300	-
	DEPTH	490	490	490	490	490	490	490	-
EQUIPMENT	LEGS HEIGHT 100	✓	✓	✓	✓	✓	✓	✓	-
	SHELF	✓	✓	✓	✓	✓	✓	✓	-
	BAR WITH HOOKS	✓	✓	✓	✓	✓	✓	✓	-
	CLOTHING HOOK	✓	✓	✓	✓	✓	✓	✓	-
	KEY LOCK	✓	✓	✓	✓	✓	✓	✓	-
	PADLOCK LOCK	✓	✓	✓	✓	✓	✓	✓	-

+	TYPES OF LOCKS	AVAILABLE TYPES OF LOCKS: PAGE 16
	ADDITIONAL OPTIONS	AVAILABLE ADDITIONAL OPTIONS: PAGE 10
	COLOR OPTIONS	AVAILABLE COLOR OPTIONS: PAGE 20

ARTUS HPL lockers on profiles

Three-level lockers

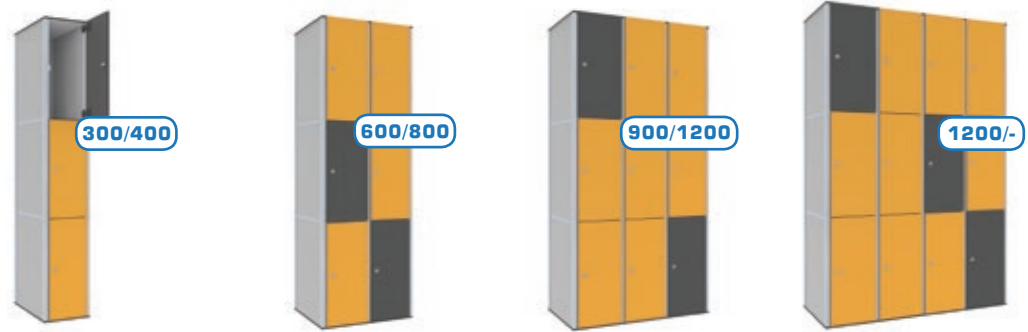

STANDARD VERSION

DIMENSIONS	PRODUCT CODE	AD-15313-00	AD-15413-00	AD-15323-00	AD-15423-00	AD-15333-00	AD-15433-00	AD-15343-00	-
	HEIGHT	1510	1510	1510	1510	1510	1510	1510	-
	PRODUCT CODE	AD-18313-00	AD-18413-00	AD-18323-00	AD-18423-00	AD-18333-00	AD-18433-00	AD-18343-00	-
	HEIGHT	1810	1810	1810	1810	1810	1810	1810	-
	OVERALL WIDTH	300	400	600	800	900	1200	1200	-
	COLUMN WIDTH	1X300	1X400	2X300	2X400	3X300	3X400	4X300	-
DEPTH	490	490	490	490	490	490	490	-	
EQUIPMENT	LEGS HEIGHT 100	✓	✓	✓	✓	✓	✓	✓	-
	SHELF	-	-	-	-	-	-	-	-
	BAR WITH HOOKS	-	-	-	-	-	-	-	-
	CLOTHING HOOK	✓	✓	✓	✓	✓	✓	✓	-
	KEY LOCK	✓	✓	✓	✓	✓	✓	✓	-
PADLOCK LOCK	✓	✓	✓	✓	✓	✓	✓	-	
+	TYPES OF LOCKS	AVAILABLE TYPES OF LOCKS: PAGE 16							
	ADDITIONAL OPTIONS	AVAILABLE ADDITIONAL OPTIONS: PAGE 10							
	COLOR OPTIONS	AVAILABLE COLOR OPTIONS: PAGE 20							

Five-level lockers



STANDARD VERSION

DIMENSIONS	PRODUCT CODE	AD-15315-00	AD-15415-00	AD-15325-00	AD-15425-00	AD-15335-00	AD-15435-00	AD-15345-00	-
	HEIGHT	1510	1510	1510	1510	1510	1510	1510	-
	PRODUCT CODE	AD-18315-00	AD-18415-00	AD-18325-00	AD-18425-00	AD-18335-00	AD-18435-00	AD-18345-00	-
	HEIGHT	1810	1810	1810	1810	1810	1810	1810	-
	OVERALL WIDTH	300	400	600	800	900	1200	1200	-
	COLUMN WIDTH	1X300	1X400	2X300	2X400	3X300	3X400	4X300	-
DEPTH	490	490	490	490	490	490	490	-	
EQUIPMENT	LEGS HEIGHT 100	✓	✓	✓	✓	✓	✓	✓	-
	SHELF	-	-	-	-	-	-	-	-
	BAR WITH HOOKS	-	-	-	-	-	-	-	-
	CLOTHING HOOK	-	-	-	-	-	-	-	-
	KEY LOCK	✓	✓	✓	✓	✓	✓	✓	-
PADLOCK LOCK	✓	✓	✓	✓	✓	✓	✓	-	
+	TYPES OF LOCKS	AVAILABLE TYPES OF LOCKS: PAGE 16							
	ADDITIONAL OPTIONS	AVAILABLE ADDITIONAL OPTIONS: PAGE 10							
	COLOR OPTIONS	AVAILABLE COLOR OPTIONS: PAGE 20							

Four-level lockers



STANDARD VERSION

DIMENSIONS	PRODUCT CODE	AD-15314-00	AD-15414-00	AD-15324-00	AD-15424-00	AD-15334-00	AD-15434-00	AD-15344-00	-
	HEIGHT	1510	1510	1510	1510	1510	1510	1510	-
	PRODUCT CODE	AD-18314-00	AD-18414-00	AD-18324-00	AD-18424-00	AD-18334-00	AD-18434-00	AD-18344-00	-
	HEIGHT	1810	1810	1810	1810	1810	1810	1810	-
	OVERALL WIDTH	300	400	600	800	900	1200	1200	-
	COLUMN WIDTH	1X300	1X400	2X300	2X400	3X300	3X400	4X300	-
DEPTH	490	490	490	490	490	490	490	-	
EQUIPMENT	LEGS HEIGHT 100	✓	✓	✓	✓	✓	✓	✓	-
	SHELF	-	-	-	-	-	-	-	-
	BAR WITH HOOKS	-	-	-	-	-	-	-	-
	CLOTHING HOOK	-	-	-	-	-	-	-	-
	KEY LOCK	✓	✓	✓	✓	✓	✓	✓	-
	PADLOCK LOCK	✓	✓	✓	✓	✓	✓	✓	-

+	TYPES OF LOCKS	AVAILABLE TYPES OF LOCKS: PAGE 16
	ADDITIONAL OPTIONS	AVAILABLE ADDITIONAL OPTIONS: PAGE 10
	COLOR OPTIONS	AVAILABLE COLOR OPTIONS: PAGE 20

Clothing lockers L



STANDARD VERSION

DIMENSIONS	PRODUCT CODE	AZ-15312-00	AZ-15412-00	AZ-15322-00	AZ-15422-00	AZ-15332-00	AZ-15432-00	AZ-15342-00	-
	HEIGHT	1510	1510	1510	1510	1510	1510	1510	-
	PRODUCT CODE	AZ-18312-00	AZ-18412-00	AZ-18322-00	AZ-18422-00	AZ-18332-00	AZ-18432-00	AZ-18342-00	-
	HEIGHT	1810	1810	1810	1810	1810	1810	1810	-
	OVERALL WIDTH	300	400	600	800	900	1200	1200	-
	COLUMN WIDTH	1X300	1X400	2X300	2X400	3X300	3X400	4X300	-
DEPTH	490	490	490	490	490	490	490	-	
EQUIPMENT	LEGS HEIGHT 100	✓	✓	✓	✓	✓	✓	✓	-
	SHELF	-	-	-	-	-	-	-	-
	BAR WITH HOOKS	✓	✓	✓	✓	✓	✓	✓	-
	CLOTHING HOOK	✓	✓	✓	✓	✓	✓	✓	-
	KEY LOCK	✓	✓	✓	✓	✓	✓	✓	-
	PADLOCK LOCK	✓	✓	✓	✓	✓	✓	✓	-

+	TYPES OF LOCKS	AVAILABLE TYPES OF LOCKS: PAGE 16
	ADDITIONAL OPTIONS	AVAILABLE ADDITIONAL OPTIONS: PAGE 10
	COLOR OPTIONS	AVAILABLE COLOR OPTIONS: PAGE 20

ARTUS lockers with piano doors



Lockers divided into three compartments

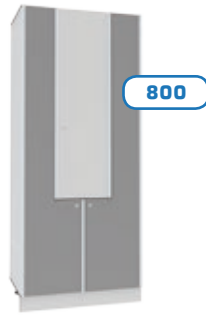

800

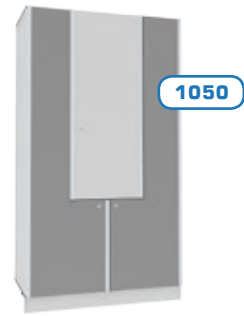

1050

STANDARD VERSION

DIMENSIONS	PRODUCT CODE	ADZ-1580	ADZ-15105
	HEIGHT	1510	1510
	PRODUCT CODE	ADZ-1880	ADZ-18105
	HEIGHT	1810	1810
	OVERALL WIDTH	800	1050
	COLUMN WIDTH	WIDTH OF COMPARTMENTS WITHOUT PROFILES - 2X190+1X300	WIDTH OF COMPARTMENTS WITHOUT PROFILES- 2X265+1X400
	DEPTH	490	490
EQUIPMENT	LEGS HEIGHT 100	✓	✓
	SHELF	✓	✓
	BAR WITH HOOKS	✓	✓
	CLOTHING HOOK	✓	✓
	KEY LOCK	✓	✓
	PADLOCK LOCK	✓	✓
+	TYPES OF LOCKS	AVAILABLE TYPES OF LOCKS: PAGE 16	
	ADDITIONAL OPTIONS	AVAILABLE ADDITIONAL OPTIONS: PAGE 10	
	COLOR OPTIONS	AVAILABLE COLOR OPTIONS: PAGE 20	

patented hinge manufactured by ALSANIT

stable, aluminum rod and durable hooks manufactured by ALSANIT

as a standard - key lock or a padlock

body and back: HPL 4 mm

doors: HPL 10/12 mm

polyamide leg

available additional options

page 10 →

available lock options

page 10 →

available colors

page 20 →

Additional options



AVAILABLE FOR LOCKERS MADE OF:

	HPL	METAL	MFC
PLATE 30X30	✓	✓	✓
PLATE 35X60	✓	✓	✓
PLATE 45X120	✓	✓	✓
ENGRAVING	✓	-	-
BAR WITH HOOKS	✓	✓	✓
ANTI-BURGLARY SYSTEM	✓	-	✓

POSSIBILITY OF MAKING FROM:

	HPL	METAL	MFC
CUSTOM DIVISION	✓	✓	✓
SLANTED ROOF	✓	✓	-
PLINTH	✓	✓	✓
LEG COVERS	✓	-	✓



Connecting lockers into wardrobes

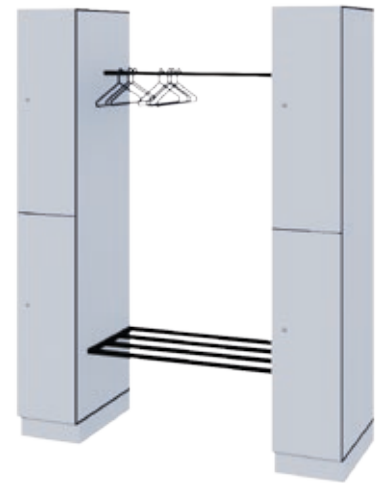
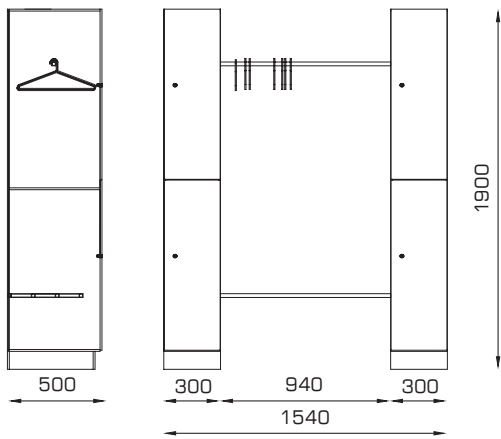

Side and corner covers

HPL / MFC / METAL

MIRROR

HPL / MFC / METAL

VANITY - functional and compact

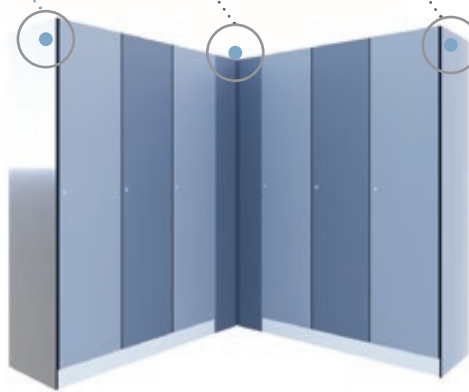



BENCHES

Benches are the perfect add on to any locker room.

Properly chosen, they can add character to the interior - make it more friendly and inviting.

available
colors



page 20 →

Benches PRO-FI

HPL

← back

10 mm

12 mm

Classic approach

Aluminum construction with seats made of HPL.
Standard ALSANIT benches.

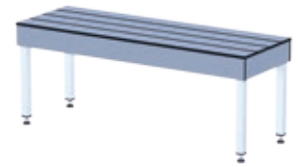
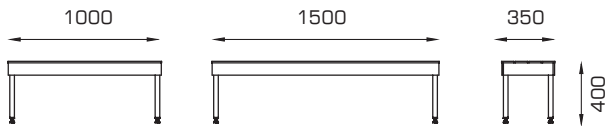
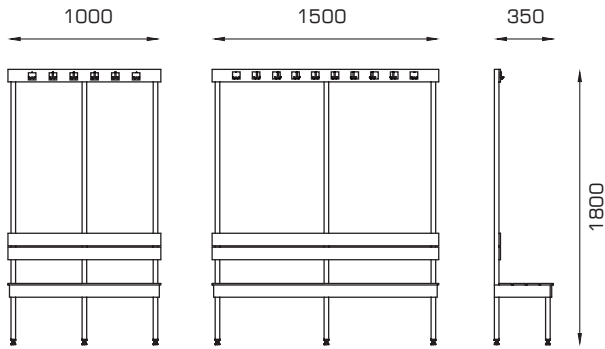

Benches LO-FI

HPL

10 mm

12 mm

Metal bench with an eye-catching seat

An elegant combination of steel and wood-like HPL panels.
Optionally include hooks.

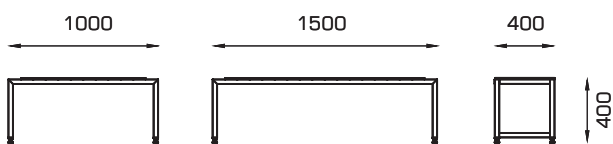
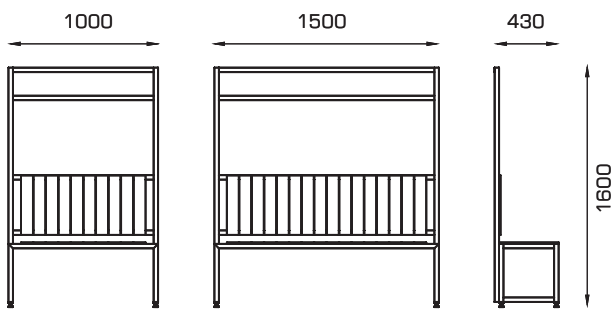

Benches HI-FI

HPL

10 mm

12 mm

Openwork backs

Steel frames with HPL seats.

Optionally include hooks.

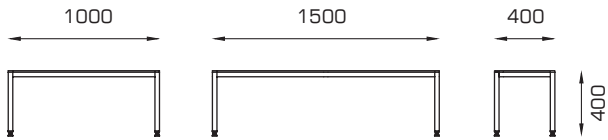
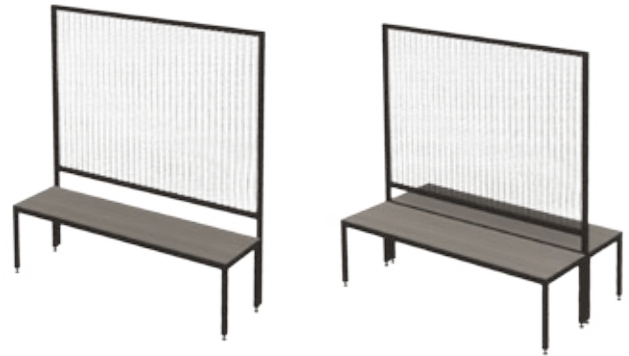
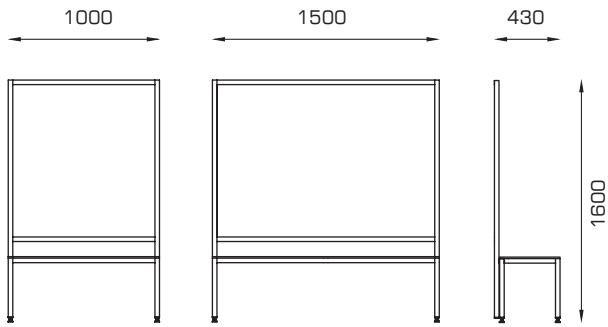

Options - available for any model

Option with low backrest

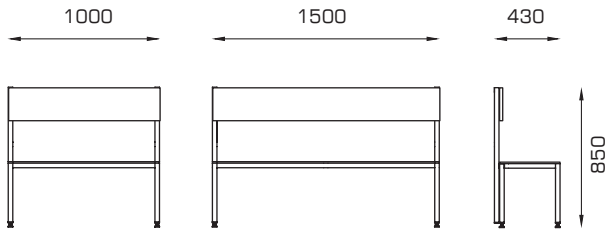

Optional slat direction for seats

Optional shoe shelf



Upholstered benches

← back

Elegance and comfort

The combination of a classic bench with elegant upholstery - beauty and elegance encapsulated in a simple minimalist form. Perfect for both modern and classical interiors.

IRIS

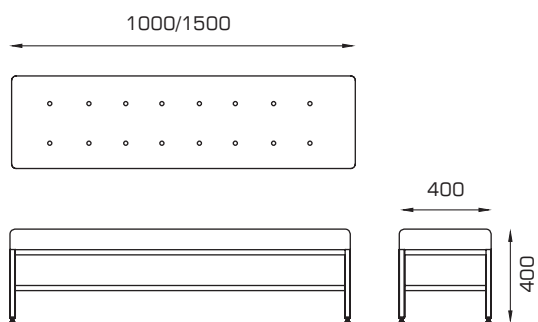

LANDO

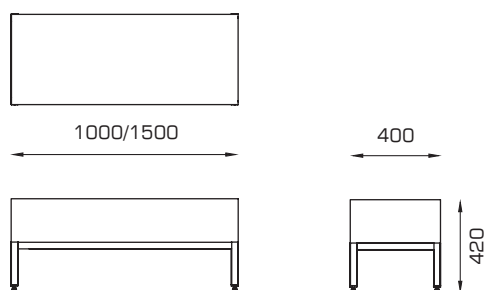

Locks for lockers

Security - a common value of the locks we offer, that is why we only provide those from reputable manufacturers. Below, we describe three additional features that guided us in selecting the locks for our products.

Waterproofnes - prepared to work in any conditions.

Prioritizing quality above all, we have decided that all locks offered by us are suitable for use in moist areas.

Interchangeability - lock models can be exchanged at any time, changing from a lower model to a higher one. This way, the locker room can be modernized without the need for costly door replacement. When changing locks to deposit or electronic locks, additional holes will have to be made in doors.

Availability - don't waste time waiting.

A strong aspect of our offer is the availability of locks on stock, significantly reducing the time needed to complete the order. For projects with slot or digital locks above 200 compartments, please contact us to confirm availability.

Cam locks, the locks we offer have a 1/1000 combination, meaning the chance of opening with your key any another locker is 0.1%.



Padlock locks, an alternative to key locks is padlocks. The recommended shackle diameter for padlocks is 5-7 mm.



The option to use any lock.

We are not limited to our own selection; we can integrate the locker with any lock specified by the client.

Code locks are maintenance-free solutions. All code locks offered by us have a master key opening option in case the code is forgotten.



Deposit locks, Coin-operated or token-operated locks are capable of accepting coins or tokens into a special container. Locks can operate on coins of 1/2 EUR. In case of key loss, locks can be opened using a master key.



Electronic lock that support the standard RFID are modern programmable locks operated by CARDS, WRISTBANDS, or other RFID TOKENS. Available in both OFFLINE versions powered by batteries and ONLINE versions powered externally.





SMART LOCKER transforms lockers into solutions

ALSANIT introduces innovative solutions in the field of lockers with smart locks, enabling electronic control over them.

Thanks to cooperation with the renowned brand SMART LOCKER, representing the most advanced intelligent locking system available on the market, we can confidently offer this solution to our customers.

SMART LOCKER stands out not only for its ease of use but also for its rich configuration options, ensuring easy management and convenient use.



The possibility of integration for any ALSANIT locker system



Full service including installation and training



The ability to integrate with the client's database



The ability to customize the software to individual needs

SMART LOCKER is an intelligent locker system that introduces a new era of facility management.

Examples of applications by industry

INDUSTRIES

	OFFICES	SCHOOLS	STORES	PHARMACY	FACTORIES	SPORTS FACILITIES	LOGISTICS SHIPMENTS	HEALTHCARE	PUBLIC AREAS	GASTRONOMY
FUNCTIONS										
STORAGE	✓	✓				✓		✓	✓	✓
DISPENSE	✓	✓	✓	✓	✓	✓	✓	✓		
DROP OFF / PICK UP	✓	✓	✓		✓		✓		✓	
CLOAKROOM	✓	✓	✓		✓	✓	✓	✓	✓	✓

- Receive all your parcels from any carrier in one place.
- Effortlessly dispense workwear or distribute mail.
- Exchange documents or keys using easily managed lockers.
- Reduce costs by flexibly assigning users to lockers in the changing room.
- Control the circulation of tools or electronic equipment.
- Earn money by selling oversized items in hospitals, sports facilities, etc.

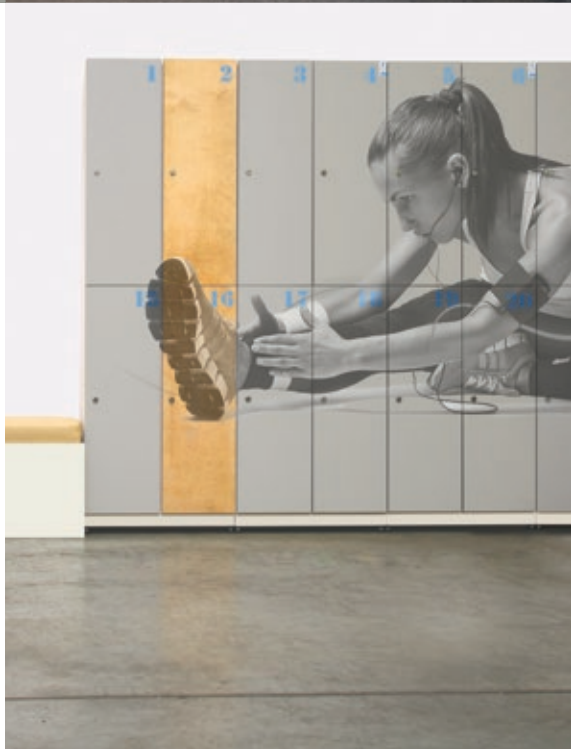



The **STOCK** version - at no extra cost

Take advantage of our extensive stock collection of available HPL, MFC, and GLASS, as well as metal paint, and configure furniture at no extra cost. There are countless configuration possibilities.

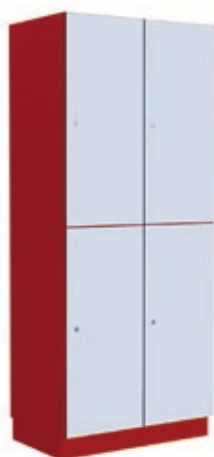

The **EXTENDED** Version - extra charge

If you would like to have the furniture bodies made in colors other than those originally designated for bodies, there is an additional surcharge of +15%.



BESPOKE Version - custom color scheme upon individual request

In addition to non-standard board colors, we can also enrich the project with graphics or decals. If you wish for colors not available in our warehouse collection, you can choose any board color, paint, or decor from the available palette, and we will order it for you.

HPL + MFC - available from the ALSANIT board suppliers' collections
PAINT FOR METAL + GLASS - available from the RAL color collection

COLORS stock collection

HPL

LOCKERS

HPL BUILT-INS

CUBICLES

CONTRACT FURNITURE

standard colors of locker bodies
standard colors of Sandwich Panels



colors available only for lockers and furniture

METAL

LOCKERS

standard colors of locker bodies

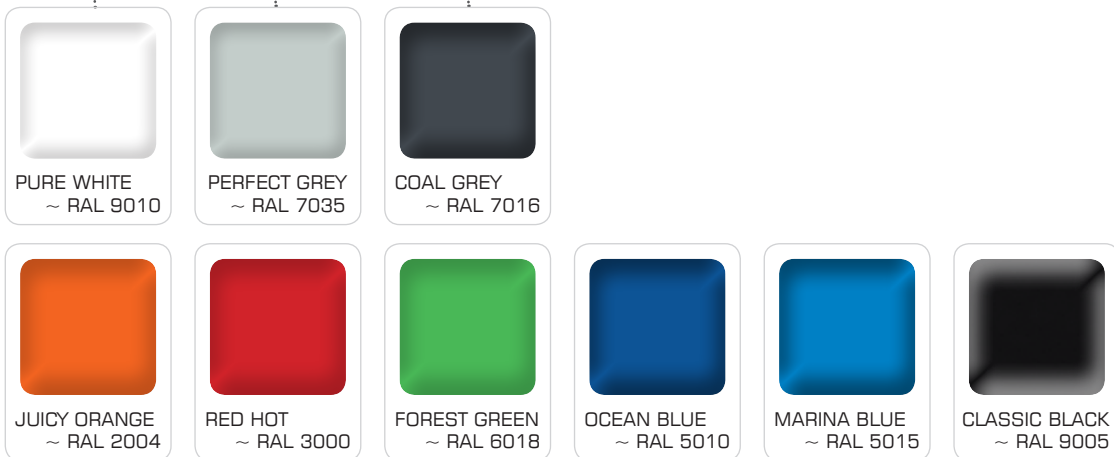

* sample colors

MFC

LOCKERS

CUBICLES

CONTRACT FURNITURE



the color range is also available in the HIGH GLOSS version

GLASS

LOCKERS

CUBICLES



* sample colors



20+

20 years of experience

25+

sales to over 25 countries

2600+

2600 projects annually

8000+

sqm of ALSANIT's hall space

40000+

doors produced annually

Lockers made of HPL, which construction is made using patented system of aluminum profiles.

ARTUS lockers ensure strength and durability for many years, while maintaining a modern look and functionality.



ALSANIT®

Alsanit Sp. z o.o.

ul. Wieleńska 2, 64-980 Trzcianka, POLSKA

+48 67 253 23 60

export@alsanit.eu

www.alsanit.eu